

3D Gyroscopic Periodic Table

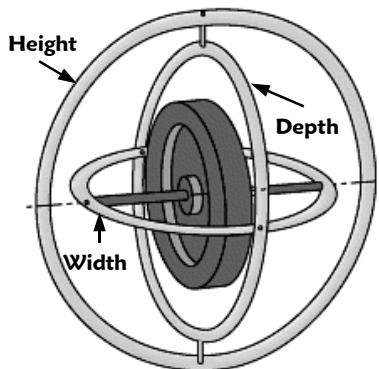

So far in 'Biodynamic Chemistry', I have presented all the diagrams as 2 dimensional images, when in fact they need to be seen as 3 dimensional.

In "The Overview", I presented the two main reference structures of Biodynamics. These being the 'passive rings' gyroscopic diagram of the World spheres of the Galaxy, Solar System, Atmosphere etc, and the 'moving vortex' gyroscopic diagram, of how the spiritual bodies; Spirit, Astral, Etheric and Physical bodies, organise themselves within living organisms. So each of these images have to be moved to 3D images.

Classically, the gyroscope can be described as having three main axis. Height, width and depth. Two of these, height and depth are on the vertical and are at a 90 degree angle to each other, while width is on the horizontal.

Within the biodynamic model we identify the vertical plane(s), as associated with the Silica and Spirit / Force processes, while we associate the horizontal plane with the Calcium and Earthly / Substance processes.

In Astronomy, we easily identify the horizontal plane in Galaxies and Solar Systems, as the plane of the matter buildup. This is the flat plane of where the stars and planets are in their respective structures. The vertical axis is often invisible in astronomy, however it is the plane where the vertical vortexes draw forces and matter into the center of the 'organism', before it is squirted out along the horizontal plane.

The third axis , the second vertical axis, is not commonly seen within galaxies or Solar Systems, however recent Hubble telescope photographs of 'Gyroscopic Galaxies' provide images of the usual flat plane of the spiral galaxy with a perpendicular ring around it.

This is a very interesting form, that will be of special interest when we come to observe the 3D organisation of the Periodic Table. For now though it is enough to observe this as the second vertical axis.

So when we draw the World spheres of our environment - the passive spheres - as a 3D picture we obtain the following image. Naturally the spheres within this diagram should be circular. I have left the straight lines in these diagrams to provide continuity with the earlier diagrams.

Likewise for the Vortex gyroscope - where the spiritual bodies organise themselves

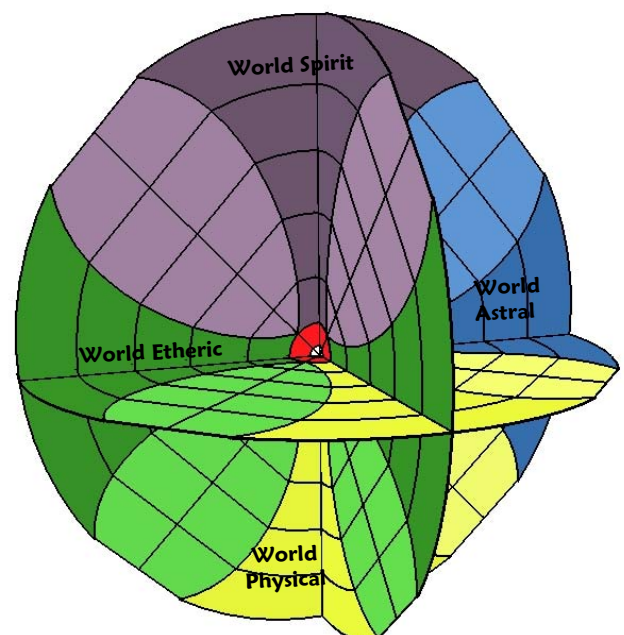
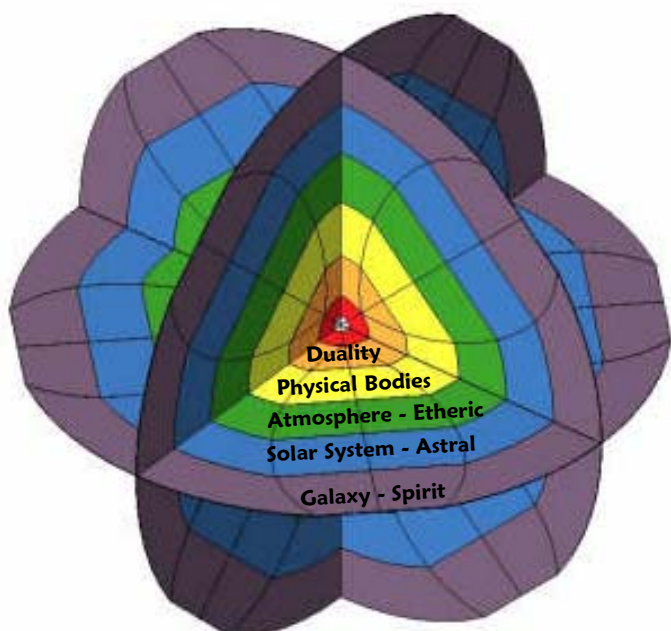
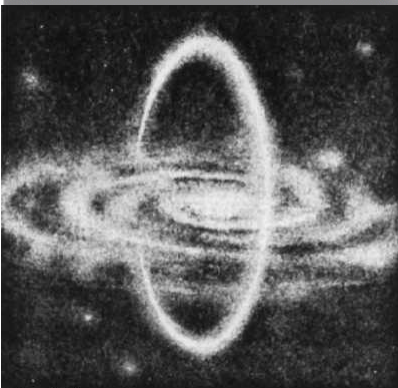
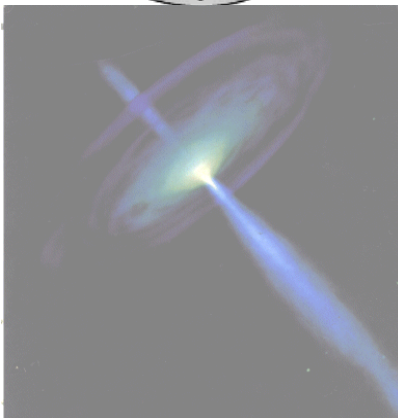

once movement is brought into play - we have the second organisation.

This 3D organisation of the Vortex gyroscope has brought about an interesting insight that is not immediately obvious when viewing the 2D diagrams. In the 2D diagram I presented, on page 7, the primary vertical axis of the gyroscope, are where the Physical body and the Spirit were placed as opposites on the vertical axis, with the Etheric and Astral as opposites on the horizontal plane. This follows indications from Dr Steiner given in "The Anthroposophical Approach to Medicine" (1922). In my applications of this 2D diagram, especially when applied to the Periodic Table, it became clear, that when viewing the diagram, the Etheric would be on the left hand side of the diagram and the Astral would be on the right hand side of the diagram, (see pg 17). In the referencing process, used for gaining insights into the Trace Elements (pg 31) and the Actinoids and Lanthanoids (pg 41) , I used this same organised pattern to identify and suggest their inner relationships and spiritual activity.

So continuing that image on, when moving to the 3D, I have taken it that each of these three planes has this basic fourfold organisational pattern as their base. When these four primary vortices are maintained as 'fully focused' vortices, of their particular body, ie a Spirit vortex, an Astral vortex, a Etheric vortex and a Physical vortex, as is suggested in the 2D diagram, we are provided with the image presented here and on page 1.

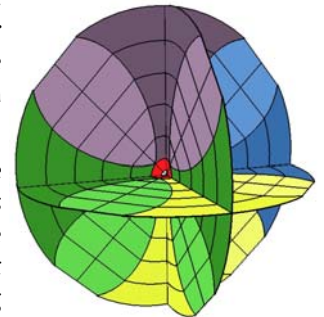

What does appear as an anomaly though, is the second vertical axis, where it crosses the horizontal axis. Here we have a region where the Physical zone of the horizontal axis (yellow) crosses the Etheric zone (green) of the vertical axis. Likewise, on the other side of the 3D diagram, we have the Astral zone of the vertical intersecting with the Spirit zone of the horizontal axis. A significant reference in life, of these bodies working together in these partnerships, is seen externally in nature, as Water and Earth processes moving upwards from the Earth, meeting the Light and Warmth of the Atmosphere. It is at their point of meeting, the oceans surface, that Blue Green Algae 'emerged', sparking evolution.

The Periodic table has also been presented as a two dimensional circular representation of a 3 dimensional spherical reality — the gyroscope. The next stage of accurately representing this image is to move it into a truly 3D picture.

Within the process of 'observing' the Periodic table, I identified that there are three groupings of elements, which each vibrate at a different frequency, and thus suggesting they inhabit different dimensions. These three dimensions are, the Major elements that work on the fourth harmonic, the trace elements that work on the fifth harmonic and the Actinoids and Lanthanoids work upon the seventh harmonic. Each of these have some specific characteristics. In my earlier diagrams I placed them on top of each other to identify their interrelationships.

The 'Major' 4th harmonic elements form the basis of manifestation. They are the base elements that are found in the environment and form the basic elements that provided the structures of many forms and activities. They are found at every ring of the Periodic Table. Generally, the elements in the inner rings are those that most actively support life, while the further out in the spheres one goes, the more toxic the elements become. Very few of the major elements found to support life are placed beyond the fourth or Etheric (green) sphere of the Periodic table.

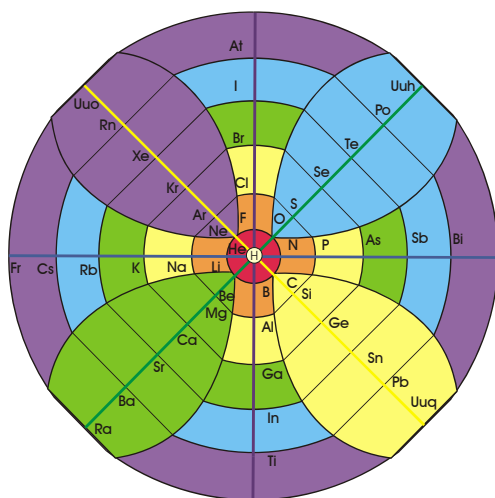

The major elements begin with Hydrogen, which is placed at the very center, of the Periodic Table. This central position, when found in the Galaxy or Solar System or the human, is the position of the internalised spirit. It is the central core of 'the individuality', at whatever level, which provides the focusing center, or spirit, around which everything in that dimension organises itself. In the 3D form, these Major elements - the fourth harmonic structural elements - would be placed on the fourfold primary vertical plane of the gyroscope.

The Trace, 5th harmonic, elements are those that become active as catalysts in biological processes, and allow life processes to come into formation and be maintained. These do not start to appear on the Periodic Table until the fourth /etheric /life body sphere. Lifeforms can

only begin to form when the etheric body becomes active in creation. It is this life element in all things and its incarnation and exit, (along with the spirit), that is the key element in the difference between life and death. Within the organised gyroscopic spheres of our environment, the matter always appears along the horizontal plane. Thus

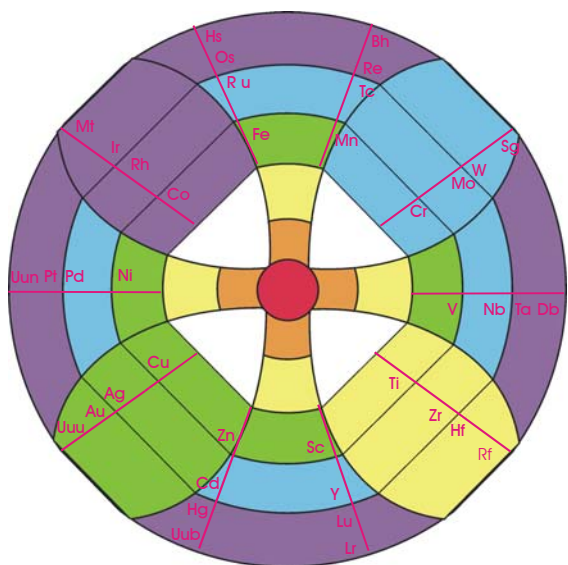

life within the gyroscope, is found on the horizontal plane, and therefore the transition elements are best placed on the horizontal plane.

The Actinoids and Lanthanoids are rare earth and radioactive elements and are found on the outer most rings of the Periodic Table. This outer ring, being the galaxy, is the World spirit sphere. If the center of these diagrams represent , the Unity, and the placement of the individualised spirit, this outer ring is the World Spirit.

Within the biodynamic reference of plant growth we are presented with two Silica processes. One coming from inside the plant upwards called the Cosmic Silica / Cosmic Forces process, coming from the Earth, and another coming from the environment in the light and the warmth called the Terrestrial Silica / Cosmic Matter. This external light and warmth process strongly influences the skin formation of the fruit, while the internal silica process is found in the formation of the seed within the fruit. This outer Galactic ring is the 'skin', boundary setting influence, of the World spirit sphere.

Given that this outer sphere is a spiritual sphere, we would expect to place these 7th harmonic elements, on a vertical axis.

The Hubble telescope has recently found Galaxies that have a vertical ring around the outer perimeter of the sphere. Thus it seems appropriate to see the second vertical plane as a ring, and that this is the place for the Actinoids and Lanthanoids are to be placed.

Putting these three planes together the follow pictures results.

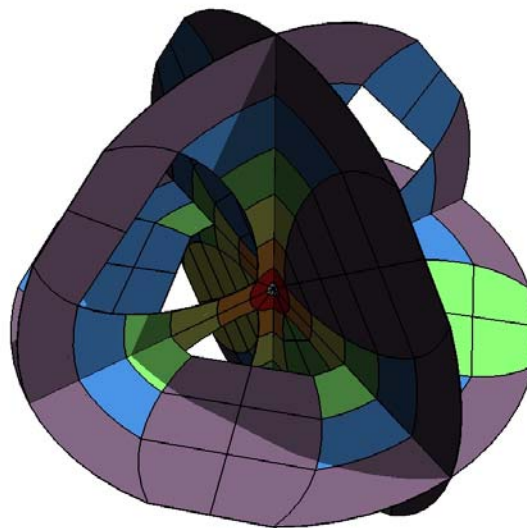
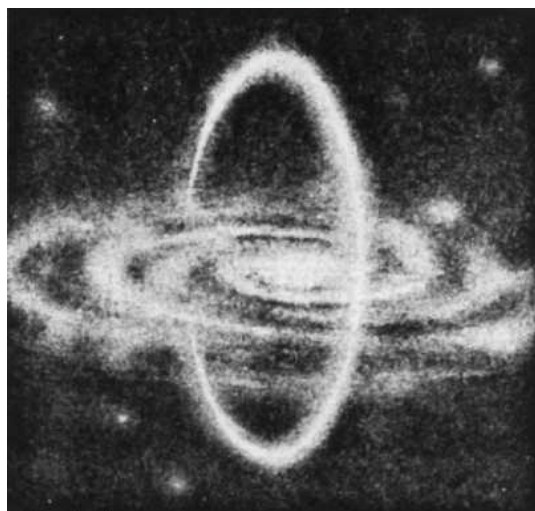
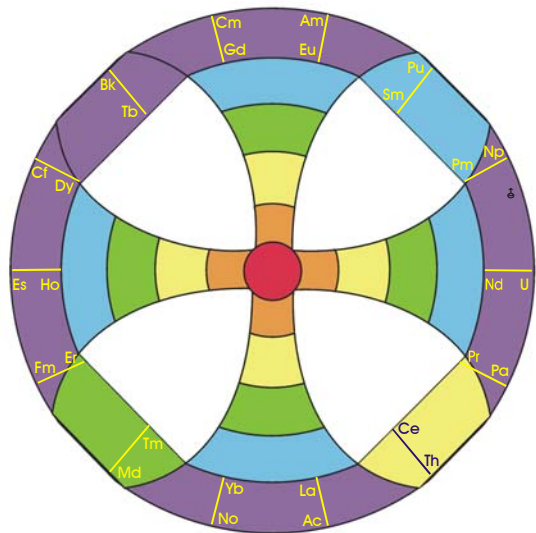

The 'anomaly' of the second vertical axis, (see pg 2) where we find the combined Physical / Etheric Vortex and the Astral / Spirit Vortex; corresponds with there being only the Actinoids and Lanthanoids on that plane. This presents us with something to contemplate.

As this outer ring only has manifest elements, it suggests the discordance of this interaction, within these vortices, does not allow those areas to form matter, other than on the outer ring. Even then these elements are very unstable being Rare Earths or radio active.

